

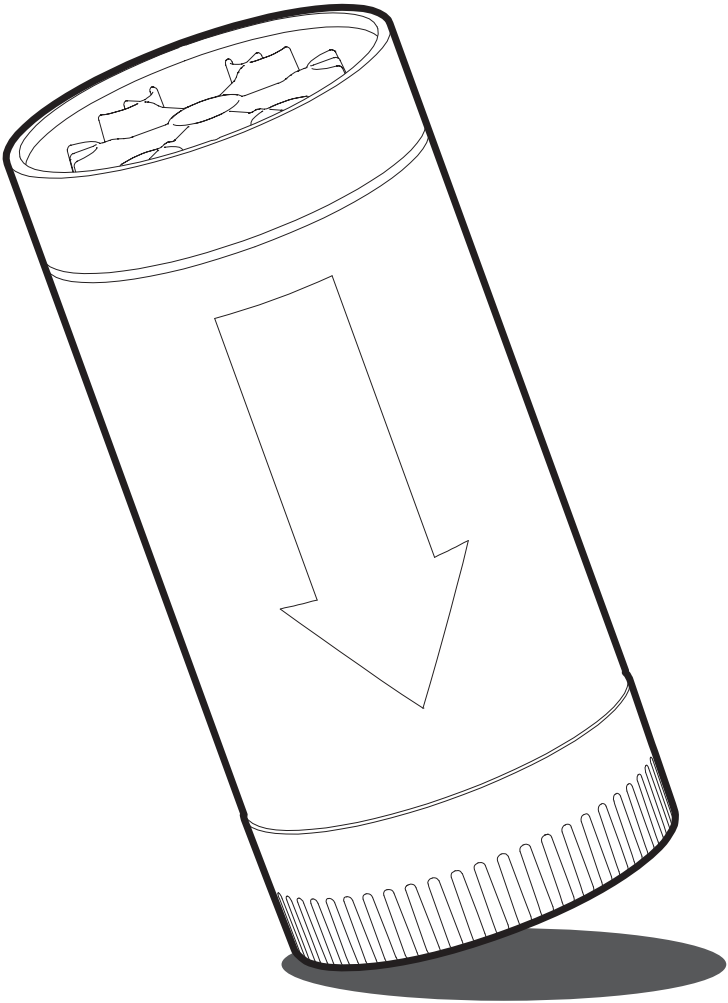

SAUCE GUN BOTTLE



www.ffoinnovations.com



WASH ALL PARTS IN
HOT, SOAPY WATER
BEFORE FIRST USE

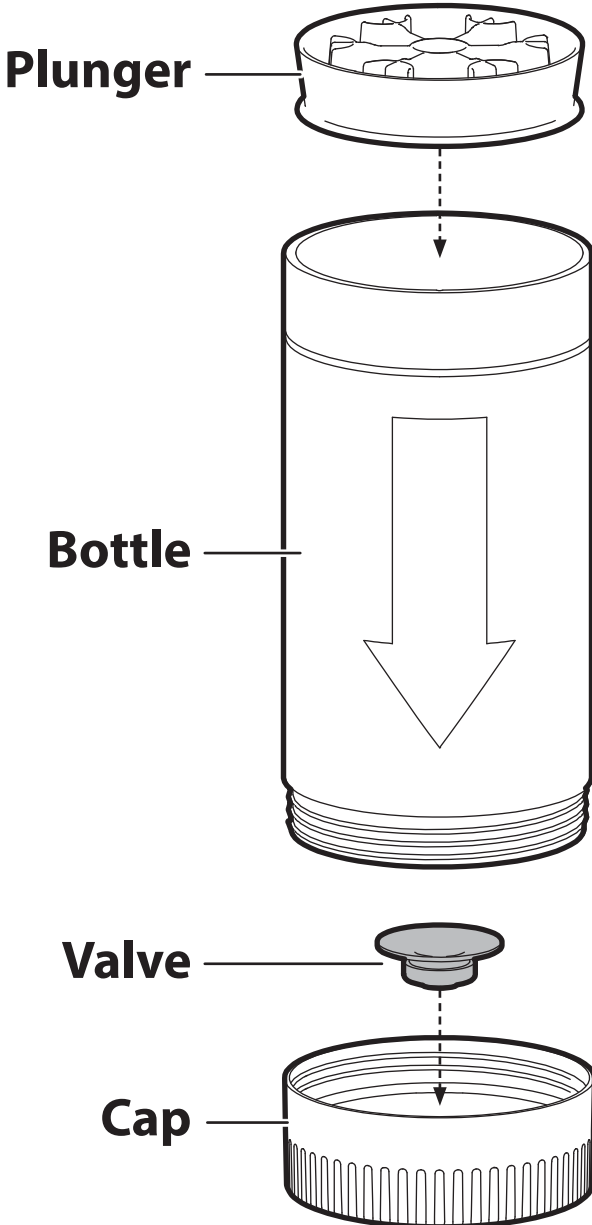

A. PREPARATION AND FILLING

1. Inspect Valve

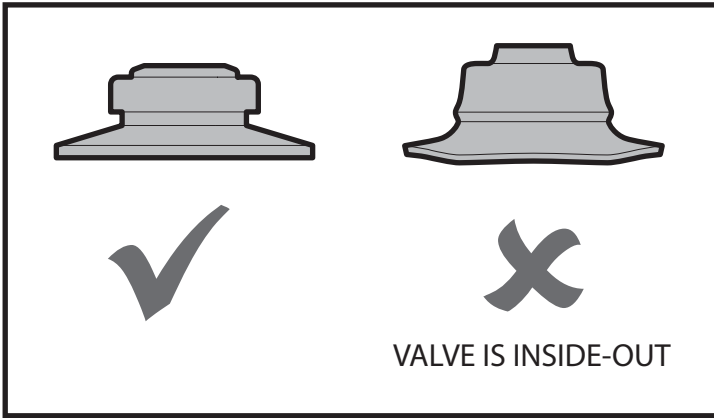

2. Place **Valve** into **Cap**, screw **Cap** onto **Bottle**

3. Fill bottle up to fill line.

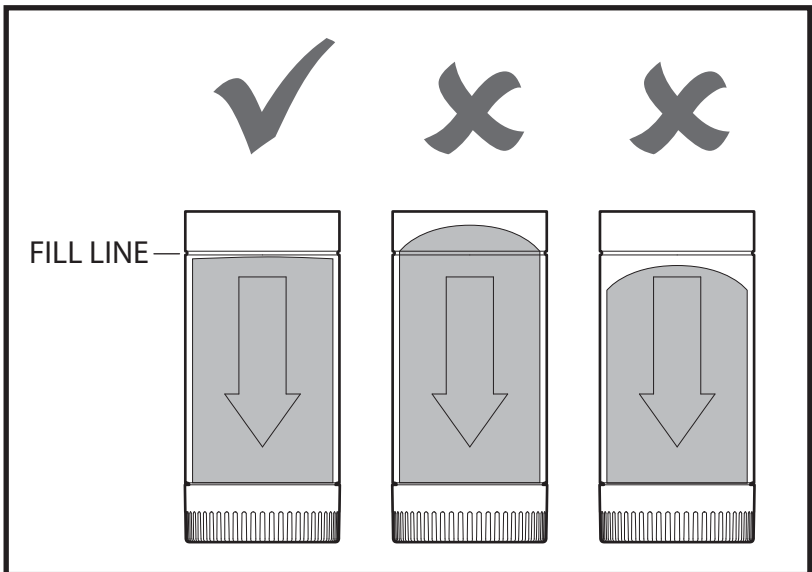

4. Press **Plunger**, flat side down, into bottle

5. Load bottle into sauce gun

B. DISASSEMBLY FOR CLEANING



Before removing bottle from sauce gun, squeeze trigger and ensure that plunger is completely at bottom

1. Remove bottle from sauce gun, unscrew **Cap**, remove **Valve**
2. Use fingertip to remove **Plunger**

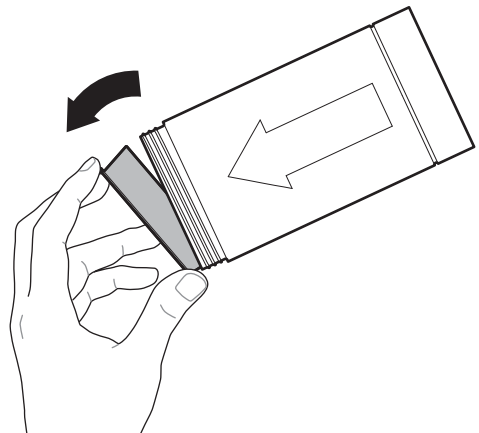
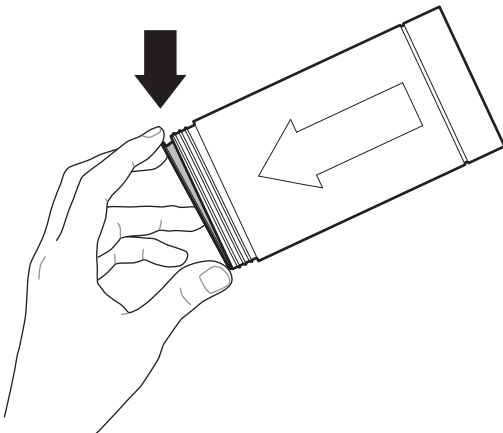
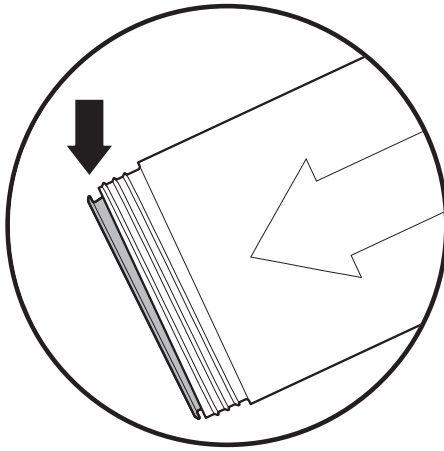

Note: Dispensed portions using Sauce Gun Bottle are about 10% less than dispensed portions from paperboard sauce tubes, a difference of about one droplet of sauce